

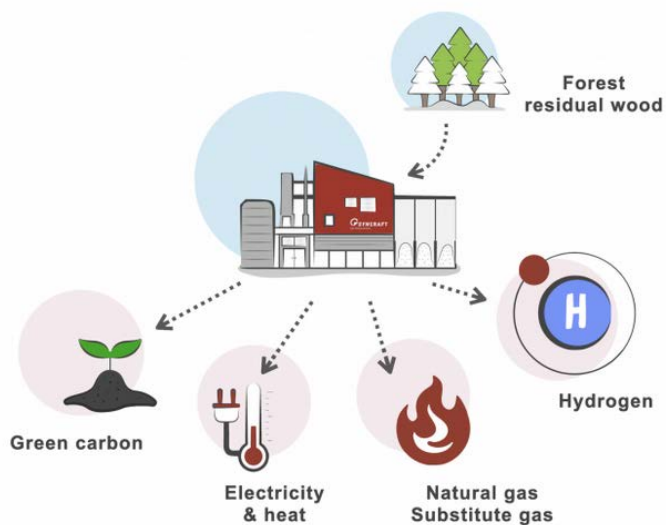

IEA Bioenergy

Technology Collaboration Programme



# Country Report Austria

## Update

Dr. Jitka Hrbek, Prof. Christoph Pfeifer

01.12.2021, IEA Bioenergy Task 33 meeting

Source: SynCraft

*The IEA Bioenergy Technology Collaboration Programme (TCP) is organised under the auspices of the International Energy Agency (IEA) but is functionally and legally autonomous. Views, findings and publications of the IEA Bioenergy TCP do not necessarily represent the views or policies of the IEA Secretariat or its individual member countries.*

# Outline

- Brief overview on gasification in Austria
- Research on gasification
- Industry
- Implementations

# Austrian Biomass Association – new publication on gasification (October 2021)



- Wood gasification – the new option
- New sales markets for energy wood
- CHP – heat and power
- Wood diesel (FT fuel)
- Synthetic natural gas (SNG) from wood
- Local green gas (gas for industry)
- History of gasification

<https://www.biomasseverband.at/wp-content/uploads/Folder-Wood-Gas-.pdf>

# CHP facilities in Austria

## Overview wood gas systems

Plant manufacturer	Rated thermal input gasifier kW from-to	Wood gas CHP plants		Feed-in of wood gas into gas network	Local green gas	Wood diesel	Hydrogen	Biochar
		Electrical power kW from-to <sup>2)</sup>	Thermal power kW from-to <sup>2)</sup>					
Burkhardt GmbH		50-180	110-270					
Entrenco GmbH		25-50	60-120					
Fröling Heizkessel- und Behälterbau GmbH		46-56	95-115					
GLOCK ecotech GmbH		18-50	44-110					
Hargassner GmbH		20	60					
Holzenergie Wegscheid GmbH		65-133	130-270					
LiPRO Energy GmbH & CO. KG		30-50	60-90					
Polytechnik Luft- und Feuerungstechnik GmbH	400-1,500							
ReGaWatt GmbH	1,600-8,000	420-2,300	870-5,600			○	○	
Spanner Re <sup>2</sup> GmbH		35-600	79.5s-1,200					
Stadtwerke Rosenheim GmbH & Co. KG		50-180	110-380					
Syncraft® GmbH	700-3,000	200-1,000	155-1,540		x		○	x
URBAS Stahl- und Anlagenbau GmbH	500-2,000	120-600	250-1,000					
Windhager Zentralheizung GmbH	7-100							
Xylowatt S.A.	2,800-7,300	750-2,000	1,500-4,000				○	x
<b>System designer</b>								
BEST – Bioenergy and Sustainable Technologies GmbH <sup>1)</sup>	100-35,000		x		x	○	○	
GET – Güssing Energy Technologies GmbH			x	x	x	○	○	x
Güssing Renewable Energy GmbH	4,500-45,000	1,200-2,400	1,400-24,000			○	○	
Pörner Ingenieurgesellschaft mbH	500-45,000							
Repotec/Aichernig Engineering GmbH			x	x	x	○	○	x
ERNEUERBARE ENERGIE – Ing. Leo Riebenbauer GmbH		18-540	44-810		x	○	○	x
SMS group Process Technologies GmbH	1,000-20,000							

x = implemented commercial plants; ○ = no commercial systems available yet; <sup>1)</sup> research facility; <sup>2)</sup> given information applies to one module. Company information, table makes no claim to completeness.

# Bioenergy in Austria

Source: Biomasseverband

- Biomass combustion facilities
- Biomass gasification facilities

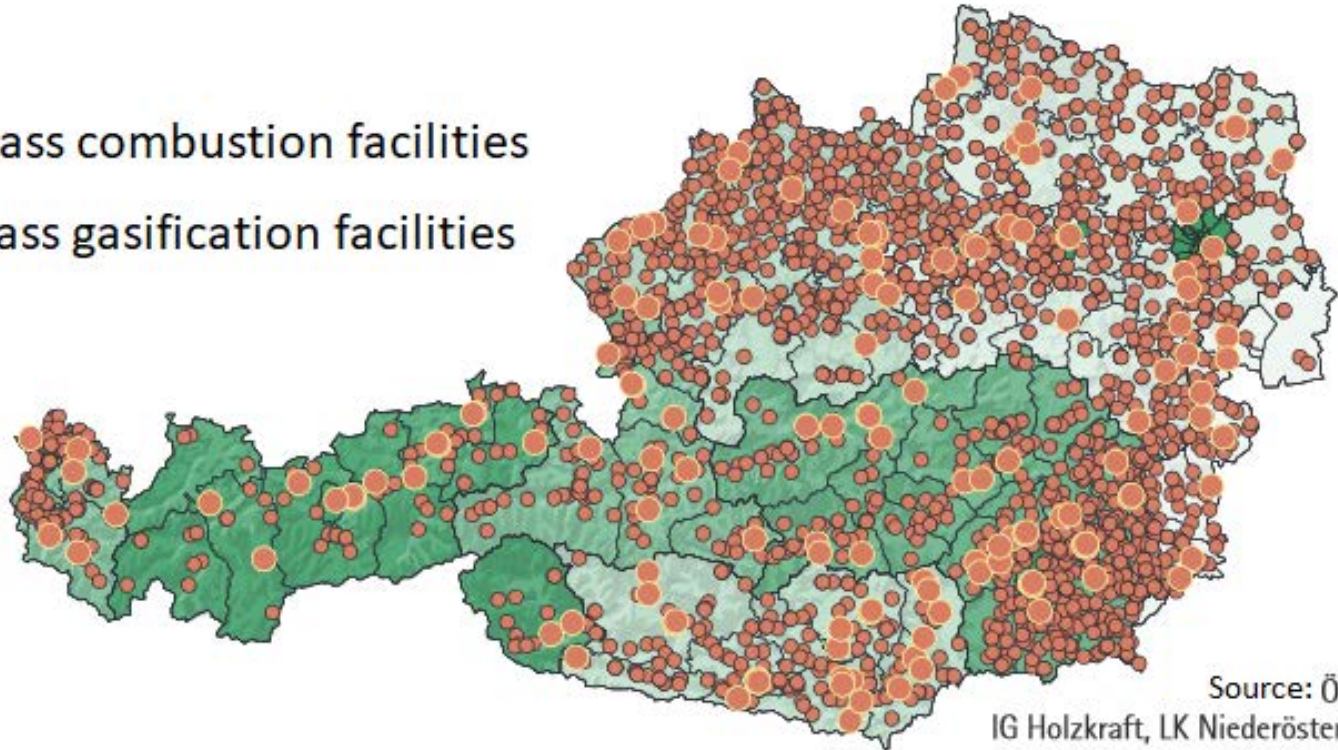

About 2 400 biomass boilers and more than 140 CHP gasification facilities

# Research in Austria

University of Natural Resources and Life Sciences Vienna  
(BOKU Wien)

Actual project:

**FLASH - Predicting the Flow behavior of ASH mixtures for production of transport biofuels in the circular economy (Forskerprosjekt - ENERGIX)**

Project period: 2018 – 2021

Partners:

- Porsgrunn, University of Norway
- Trondheim, Norway - Research institute
- Aalto, Finland - University,
- Daniel Lindberg (externer Partner)

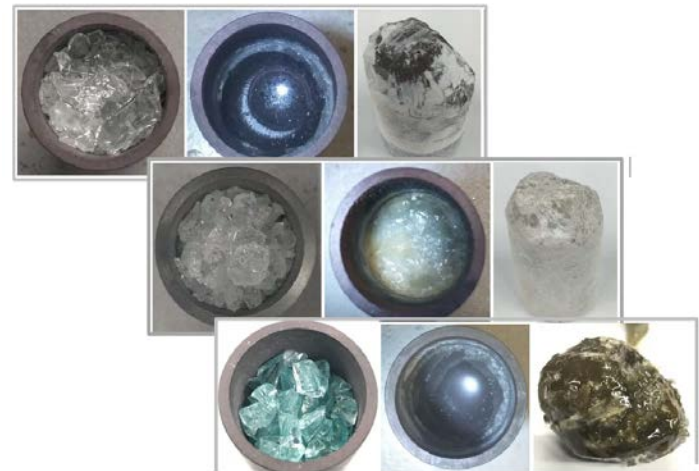



# Research in Austria

## Vienna University of Technology (TU Wien)

### Institute of Chemical Engineering



#### Actual projects:

[FCTRAC](#) (Fuel cell tractor fuelled with biogenic hydrogen)

[ADORE-SNG](#) (Comprehensive Automation, Digitalisation & Optimization of Renewable & Sustainable SNG-production)

[Waste2value](#) – together with BEST and other partners

#### Relevant publications:

Bartik, A., Benedikt, F., Lunzer, A., Walcher, C., Müller, S., Hofbauer, H., 2020, "Thermodynamic investigation of SNG production based on dual fluidized bed gasification of biogenic residues", Biomass Conversion and Biorefinery, Vol.11, p.95-110, doi: 10.1007/s13399-020-00910-y

Schmid, J.C., Benedikt, F., Fuchs, J., Mauerhofer, A.M., Müller, S., Hofbauer H., 2019, "Syngas for biorefineries from thermochemical gasification of lignocellulosic fuels and residues - 5 years' experience with an advanced dual fluidized bed gasifier design". Biomass Conversion and Biorefinery, <https://doi.org/10.1007/s13399-019-00486-2>

# Research in Austria

Vienna University of Technology (TU Wien)

Institute of Chemical Engineering



## FCTRAC – Fuel Cell TRACtor fuelled with biogenic hydrogen

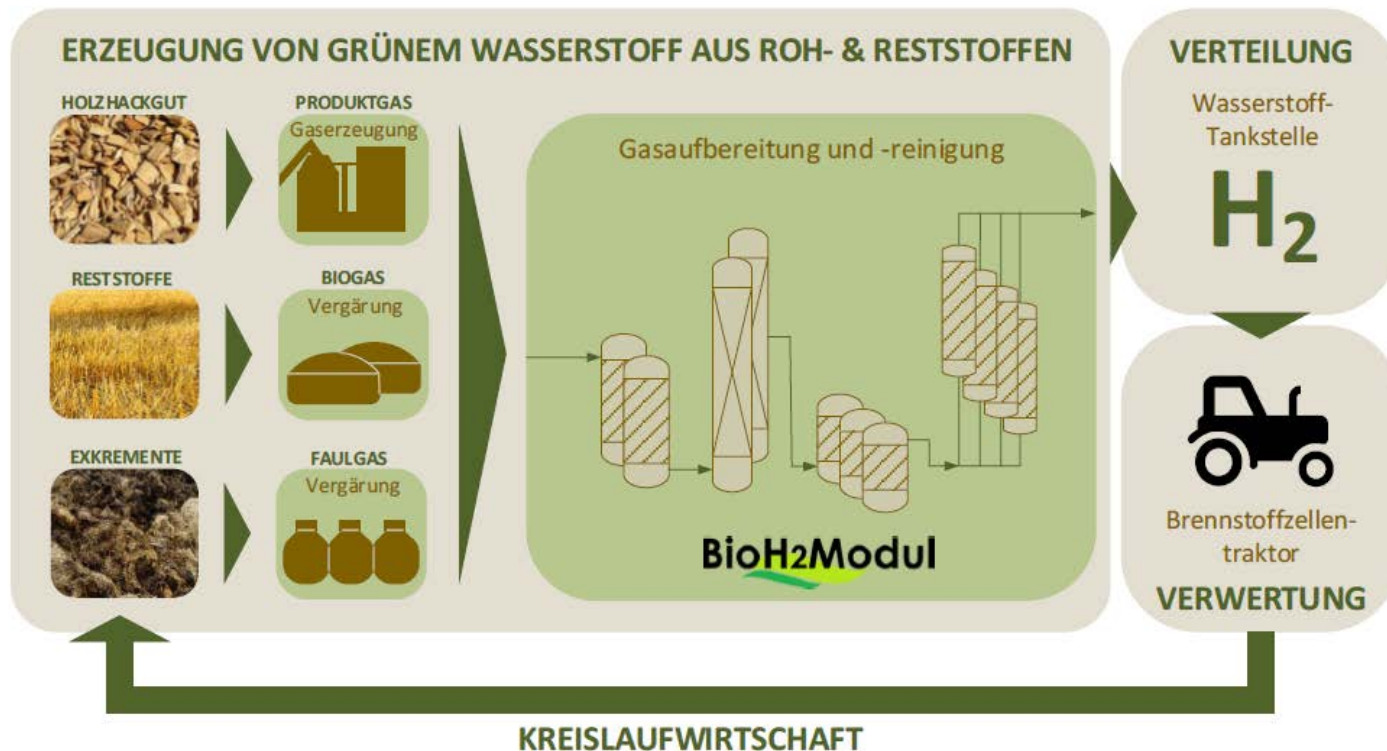



# Research in Austria

Vienna University of Technology (TU Wien)

Institute of Chemical Engineering



## FCTRAC – Fuel Cell TRACtor fuelled with biogenic hydrogen

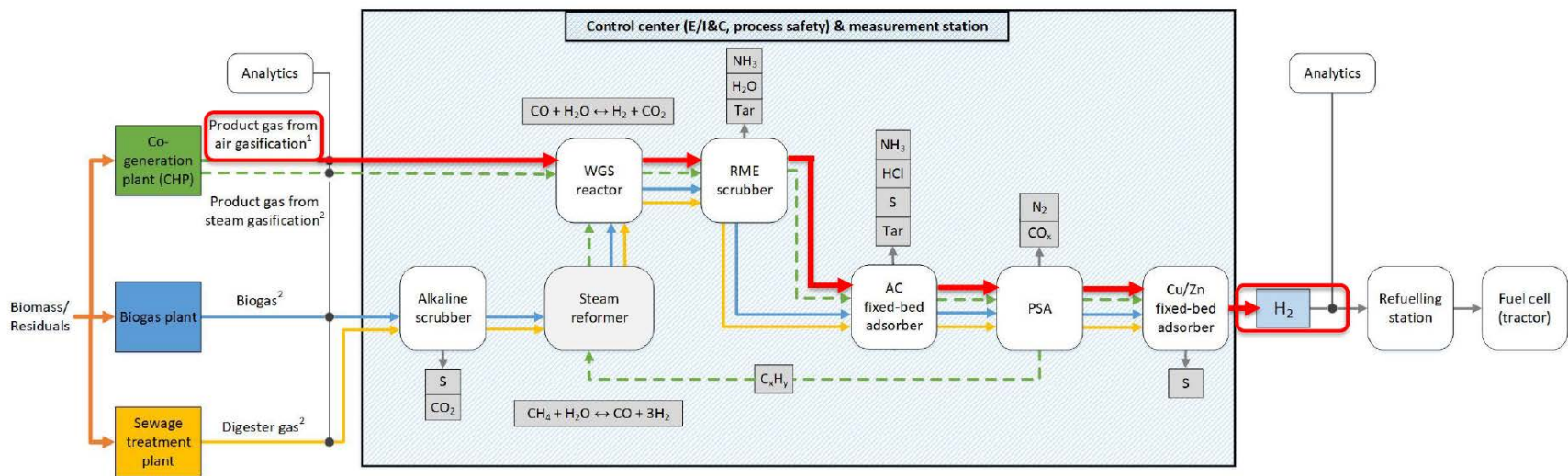

<sup>1</sup> Basis for design of BioH<sub>2</sub>Modul  
<sup>2</sup> Process simulation for flexible BioH<sub>2</sub>Modul

**BioH<sub>2</sub>Modul**

# Research in Austria

Graz University of Technology

Institute of Thermal Engineering



## Projects areas:

- Combustion and gasification
- CFD-simulations
  - reactive fluid flows
  - solar thermal processes
  - extrusion and injection molding (polymers)
  - thermal Management
- Thermo-dynamical process simulation
- Fluidized bed combustion
- Second Generation Fuels and fuel cells
- CO<sub>2</sub>-free gas- and coal-burning power plant

# Research in Austria

## MCI

University of Applied Sciences for Environmental-,  
Process- and Biotechnology, Innsbruck

### Projects areas:

- Multi-staged fixed bed gasification systems
- Valorization of biomass
- Biomass to power and heat
- Engine & emissions
- Energy distribution and storage

# Research in Austria

## MCI - Josef Ressel Zentrum



### Central goals: Production of activated carbon

- Use of waste wood/municipal wood residues as a feedstock for the production of heat/power and activated carbon
- Production of activated carbon with high specific surface (thermochemical methods, development of in-situ/ex-situ activation methods and reactors)



### Output of research year 1:

- Preparation of feedstock is essential for successful gasification
- Gasification behavior of waste wood differs from fresh wood, but can be managed by adaptation of process parameters
- Lab-scale activation successful (surface up to 1500 m<sup>2</sup>/g)



# Research in Austria

## MCI - Josef Ressel Zentrum



### Central goals: Application of activated carbon

- Activated carbon: functional groups for better adsorption behavior (e.g. heavy metals)
- Implementation in waste water treatment plants
- Use of activated carbon in other applications
  - Odor reduction
  - Water retention of urban green spaces/nutrition management



### Output of research year 1:

- Lab methods for all applications in waste water treatment are established

# Research in Austria



## Competence area - gasification:

- Product gas production/treatment/utilization
- Process development and optimization
- Measuring and analysis technology
- Fundamental R&D on ashes and bed materials
- 1<sup>st</sup> and 2<sup>nd</sup> generation biofuels
- Representative of Austria in IEA Bioenergy Task 39 liquid biofuels
- ExCo vice-chair
- Secretary of IEA Advanced Motor Fuels



# Austrian companies

## **Aichernig Engineering GmbH (former REPOTEC)**

(<http://www.repotec.at>)

Engineering of FICFB gasifiers for CHP, BioSNG and other synthesis (Güssing, Ulm, Göteborg)

## **GET- Güssing Energy Technologies**

([get.ac.at](http://get.ac.at))

Research, consulting and engineering, education centre

## **Güssing Renewable Energy**

(<http://www.gussingrenewable.com>)

## **GE Jenbacher Energiesysteme AG**

(<https://information.jenbacher.com/index.php>)

## **GRESKO Power**

<https://gresco-power.com/>

# Austrian companies

Small scale gasification - overview



Output kWel	Output kWth
18/55	44/120
20	60
50	107

# Austrian companies

Small scale gasification - overview



Output kWel	Output kWth
200-500	320-770
300/500	500/800
120-550	280-880

# Austrian companies



**SYNCRAFT®**  
Das Holzkraftwerk.

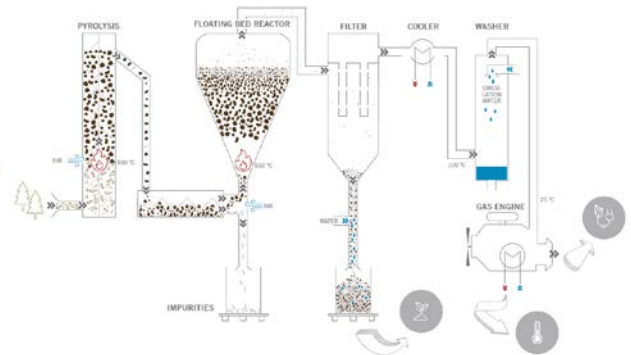

Floating fixed bed technology

1kg charcoal  
is an eq. to  
3 kg CO<sub>2</sub>

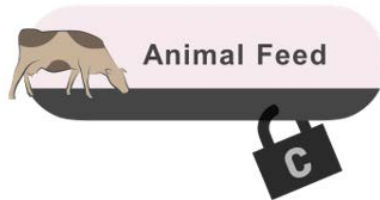
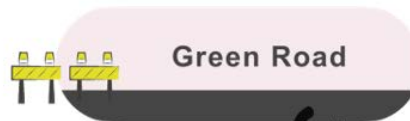
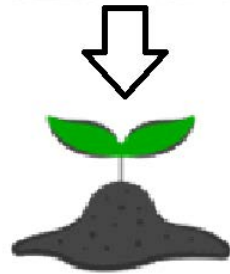

**Mission**  
negative CO<sub>2</sub> footprint

# Austrian companies



The cement industry is one of the two largest producers of carbon dioxide (CO<sub>2</sub>), creating up to 8% of worldwide man-made emissions of this gas

Ingenieurbüro Axel Preuß + SynCraft + other partners created **CarStorCon®**

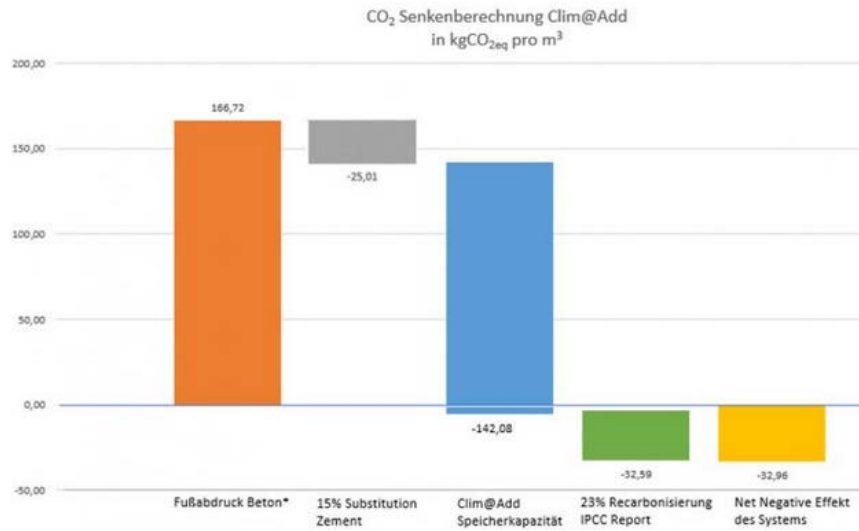

CarStorCon® Beton der Zukunft	
	CarStorCon®
Zementgehalt in (kg)	272
Anteil Clim@Add® in M% vom Zementgehalt	15
Wassergehalt in (kg)	182
W/Z-Wert(angepasst)	0,67
<b>Frischbeton:</b>	
Aussbreitmaß a10 in (mm)	500
Aussbreitmaß a30 in (mm)	450
Rohdichte in (kg/dm <sup>3</sup> )	2,31
Luftporengehalt in V%	0,8
<b>Festbeton:</b>	
Rohdichte in (kg/dm <sup>3</sup> )	2,25
<b>Druckfestigkeit in N/mm<sup>2</sup></b>	
2 Tage	18,9
7 Tage	25,8
28 Tage	33,3
56 Tage	38,7

# Project Waste2Value

## 1 MW DFB gasification + synthesis: Waste2Value

New research location at industrial site *Simmeringer Halde*

1 MW DFB gasification demonstration plant (improved reactor design) + 300 kW Fischer-Tropsch synthesis pilot plant

Research laboratory with lab-scale synthesis test-rigs (mixed alcohols, H<sub>2</sub> separation, etc.)

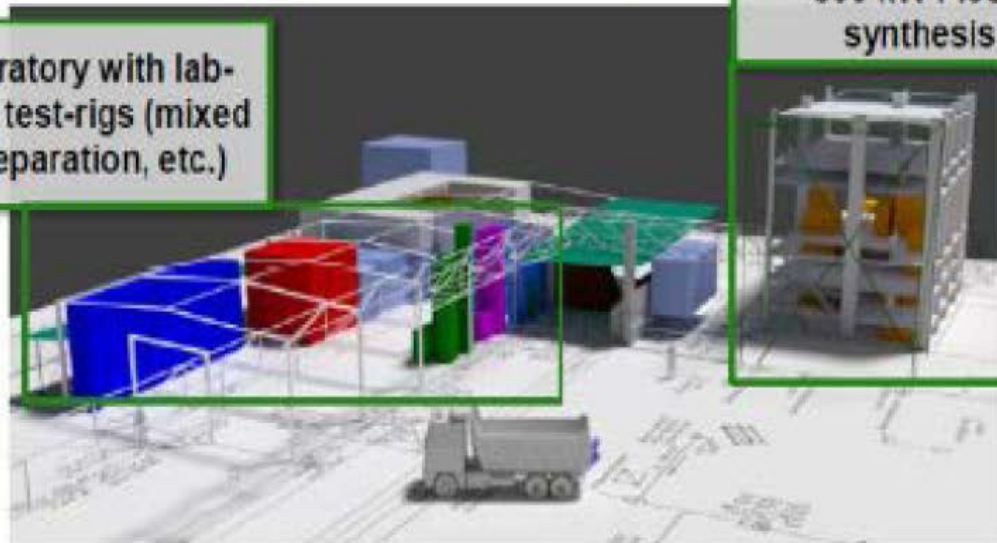

COMET  
Competence Centers for  
Excellent Technologies



# Project Waste2Value

RDF gasification, FT synthesis, SNG production, etc.



**Now commissioning**

Thanks for your attention

Dr. Jitka Hrbek

[jitka.hrbek@boku.ac.at](mailto:jitka.hrbek@boku.ac.at)

Univ.Prof. Christoph Pfeifer

[christoph.pfeifer@boku.ac.at](mailto:christoph.pfeifer@boku.ac.at)



**IEA Bioenergy**

*Technology Collaboration Programme*

[www.ieabioenergy.com](http://www.ieabioenergy.com)

- **Sweden:** check the database, if some update is needed
- **Germany:** please add also update on commercial activities 1-2 pages, please check the database
- **Italy:** Research well described in CR 2018/19., 4 additional pages for Status report received, thank you. Please add a short update on commercial activities 1-2 pages, check the database
- **USA:** Research and commercial update received, thank you. Please add description of one research project 1-2 pages. Check the database
- **NL:** Research and industrial activities received, thank you. Please add description of 1 research project (1-2 pages), check the database
- **India:** Overview on industrial activities received, thank you for that. Please add also overview on research and description of 1 research project, please complete the tables for the database, thank you a lot!
- **UK:** Please provide an overview on research institutions, commercial activities update and description of 1 research project, database checked with Sam, thank you.